

PRINTED CATALOGUE

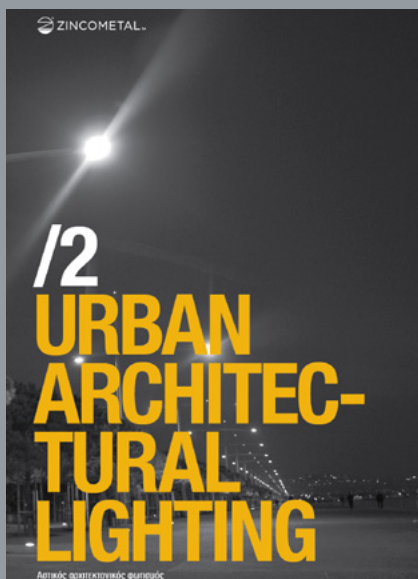

WEBSITE LINK

[/ products / lighting poles & masts / architectural lighting poles](#)

PRODUCT NO:

DESCRIPTION:

IMAGE



RUSTIC Collection



ZINCOMETAL S.A. is constantly developing and improving its products. For this reason, all product descriptions in this catalogue are intended as a general guide, and we may change specifications from time to time in the interest of product development, without prior notification or public announcement. Regarding the validity of the International Standards it is considered always the oldest edition.

Stay tuned with the company by signing up in ZINCOMETAL's Newsletter ([www.zincometal.gr](http://www.zincometal.gr)) and Social Media.

## 1.0. Decorative Steel Lighting Poles

**Introduction** Decorative steel lighting poles are separated into a range of categories according to their type of cross-section, decorative bases and their accessories, which are adjusted to suitable brackets in order to bring in the desirable aesthetic result.

These categories consist of:

- ARMONIA Collection is composed of decorative conical steel lighting poles of circular cross-section. If it is necessary, decorative brackets are fit.
- SANTA Collection is composed of decorative straight steel poles of circular cross-section and decorative scissile die-cast aluminium base.
- PLAZA Collection is composed of decorative straight, stepped or striped lighting poles of square cross-section.
- CRETA Collection is a combination of steel round conical and straight cylindrical shafts with decorative die-cast aluminium or cast-iron connectors and accessories.
- CITY Collection is a combination of stepped steel lighting poles of circular cross-section and decorative die-cast aluminium or cast-iron connectors and accessories.
- RUSTIC Collection includes conical, straight and stepped poles with stripped surface of circular cross-section, decorative cast-iron base and accessories.
- IDEA Collection includes conical poles of circular cross-section in curved or bent forms, cylindrical poles with special alteration of the section or to adjust especially designed decorative accessories in order to provide a distinguishable architectural style.



## 1.6. RUSTIC Collection

**Image 1**

Decorative steel stepped lighting pole with stripped surface of circular cross-section with a decorative bracket from the RUSTIC Collection BDK-CC 42/500 in combination with the traditional luminaire ZINLUX CAMPANA and with decorative cast-iron rings.



**Image 2**

Decorative steel stepped lighting pole with stripped surface of circular cross-section with a decorative bracket from the RUSTIC Collection BDK-CC 42/500 in combination with the traditional luminaire ZINLUX PIROFANI and with decorative cast-iron rings.



### 1.6.1. ZINLUX RUSTIC CC-R With base plate

Pole drawing model

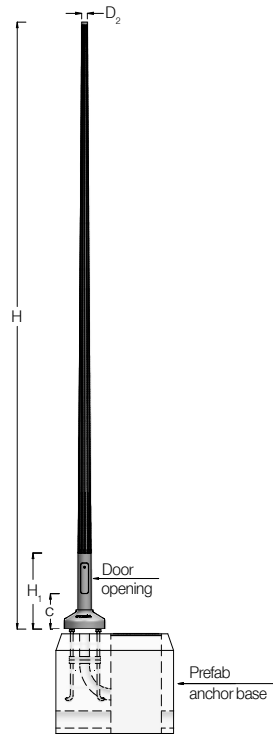

- Introduction** Decorative steel conical lighting pole ZINLUX RUSTIK CC-R with stripped surface of circular cross-section designed in traditional architectural style with circular base plate in combination with a decorative cast-iron base.
- Material** Hot rolled steel grade S235JR according to EN10025.
- Surface protection** Hot-dip galvanized according to International Standard EN ISO 1461 and electrostatic powder coating surface finish (Duplex System).
- Technical features** Round conical steel pole is made from steel sheet bend in special machines on regular circle profile with constant taper. Consisting from one (1) single piece for a pole height of up to 12m. The lighting pole is welded across with only one stitch in automatic welding machines MIG (longitudinal welding). Moreover, the surface of the body is further processed to create stripes along the pole. For a better static analysis there is a circular base plate with or without triangular gussets (depends on the headload which is totally covered by a decorative cast-iron base. Door opening is made from the body of the pole through special saw machine (IP54 and IK10). It fits tightly and it's equipped with security lock. Manufacturing according to EN-40.
- Certificates** CE Certificate of Notified European Body (EN-40, European Commission).

## Cross-section

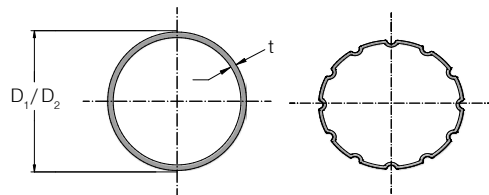

Conical circular cross-section with stripped surface ( $D_1$ : base's cross-section,  $D_2$ : top's cross-section,  $t$ : thickness).

## Door opening

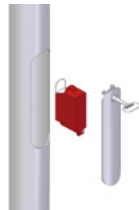

Door opening is made from the body of the pole through special saw machine. It fits tightly on the pole and is equipped with a security lock. It ensures the desirable aesthetic result. Protection IP54 through elastic gasket at the electrical compartment and protection against external mechanical impact IK10. Finally, it is accompanied with a security lock ZINCOMETAL of a triangular socket. It is user-friendly.

**Connection and safety of electrical circuit**

## Junction boxes

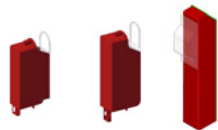

Range A-M1, A-M2, A-M3A

Junction boxes are made from polyamide resins, self-extinguishing and infrangible IP43 (A-M1, A-M2) and IP54 (A-M3A) and IK08 (A-M1, A-M2, A-M3A). It is suitable for poles of section  $\leq \Phi 110$  (A-M1) and  $\geq \Phi 120$  (A-M3A, A-M2).

## Aluminium door cover



PG A1, PG A2

An alternative choice of a door opening is the aluminium protective cover with a special lock and its own key for easy use. Protection IP55 through elastic gasket at the electrical compartment and protection against external mechanical impact IK08. It is suitable for poles of section  $\Phi 100$ - $\Phi 110$  (PG A1),  $\Phi 120$ - $\Phi 166$  (PG A2).

### Decorative details of the base

**Decorative bases** A big variety of ZINLUX decorative bases are suggested in order to provide an elegant architectural result. They perfectly cover the base plate and protect the anchor bolts.

Cast-iron base "S<sub>1</sub>"



Decorative cast-iron base "Simple" type of S<sub>1</sub> height 70mm and diameter  $\Phi$ 340mm. Material's quality is EN-GJL-200 according to DIN 1561 with the minimum strength 200MPa .

Cast-iron base "S<sub>3</sub>"



Decorative cast-iron base "Simple" type of S<sub>3</sub> height 190mm and diameter  $\Phi$ 420mm. Material's quality is EN-GJL-200 according to DIN 1561 with the minimum strength 200MPa .

### Pole anchor bases

Prefab anchor base

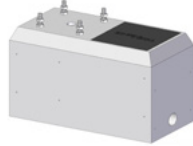

ZINCOMETAL prefab concrete base is an innovative product which aims to cover every project needs.

#### Benefits:

- Durability and Strength.
- Easy and flexible electrical works.
- It can be transported to the project.
- Installation and completion in real time to minimize cost and time.

PR-M/800/190/16

ZINCOMETAL prefab concrete base 800x600x550mm is equipped with 4 hot dip galvanized anchor bolts M16x500mm in arrangement 190x190mm, the manhole, the tube in which the cable pass through and the necessary equipment/accessories.

PR-M/1000/235/20 ZINCOMETAL prefab concrete base 1000x500x700mm is equipped with 4 hot dip galvanized anchor bolts M20x600mm in arrangement 235x235mm, the manhole, the tube in which the cable pass through and the necessary equipment/accessories. If it is necessary, it can be used as a primary base in order to construct a bigger one.

PR-SL/1000/280/24 ZINCOMETAL prefab concrete base 1000x1000x900mm is equipped with 4 hot dip galvanized anchor bolts M24x750mm in arrangement 280x280mm, the manhole, the tube in which the cable pass through and the necessary equipment/accessories.

#### Anchor base



Another alternative suggestion for installation in real time is the pole anchor base, which is delivered hot dip galvanized.











BAG M16/50/Z/190 Pole anchor base with 4 anchor bolts M16 of 500mm length each one, in arrangement 190x190mm.

BAG M20/60/Z/235 Pole anchor base with 4 anchor bolts M20 of 600mm length each one, in arrangement 235x235mm.

BAG M24/75/Z/280 Pole anchor base with 4 anchor bolts M24 of 750mm length each one, in arrangement 280x280mm.

## Table of ZINLUX RUSTIC CC-R

## With base plate

											
							Junction box	Anchor base			Prefab base
Code	mm	mm	mm	mm	mm	mm	Code	Code	mm	mm	Code
<b>RUSTIC CC-R304T</b>	4000	Φ106/Φ60	3	Φ310x10	300x70	350	A-M3A A-M1 A-M2	<b>BAG M16/50/Z/190</b>	M16x500	190x190	PR-M/800/190/16
<b>RUSTIC CC-R306T</b>	6000	Φ135/Φ60		Φ400x1	300x80			<b>BAG M20/60/Z/235</b>	M20x600	235x235	PR-M/1000/235/20
<b>RUSTIC CC-R409T1</b>	9000	Φ185/Φ76	4	400x400x12	300x85			<b>BAG M24/75/Z/280</b>	M24x750	280x280	PR-SL/1000/280/24

## 1.6.2. ZINLUX RUSTIC ST-R With base plate

Pole drawing model

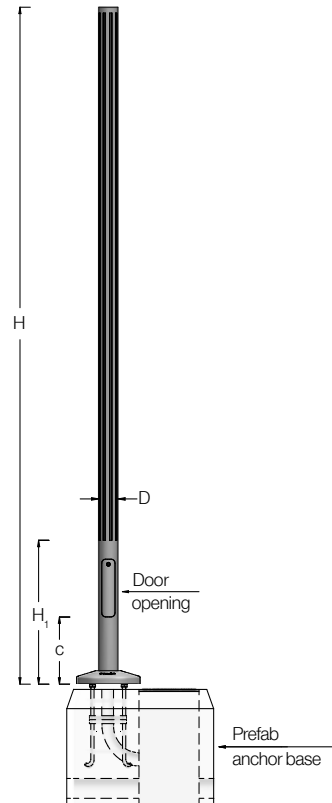

- Introduction** Decorative steel lighting pole ZINLUX RUSTIK ST-R with stripped surface of straight cross-section with circular base plate in combination with a decorative cast-iron base.
- Material** Steel tube from hot rolled steel grade S235JR according to EN10025 manufactured to EN 10219.
- Surface protection** Hot-dip galvanized according to International Standard EN ISO 1461 and electrostatic powder coating surface finish (Duplex System).
- Technical features** It is manufactured with a piece of cylindrical steel pole with stripped surface. For a better static analysis there is a base plate which is totally covered by a decorative cast-iron base. Door opening is made from the body of the pole through special saw machine (IP54 and IK10). It fits tightly and it's equipped with security lock. Manufacturing according to EN-40.
- Certificates** CE Certificate of Notified European Body (EN-40, European Commission).

Cross-section

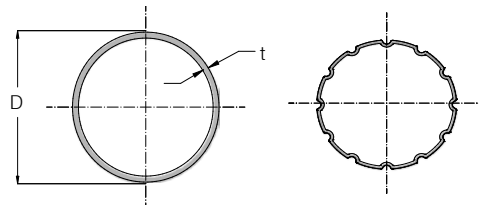

Straight pole of circular cross-section with stripped surface (D: diameter, t: thickness).

Door opening

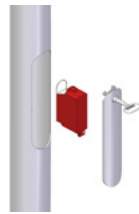

Door opening is made from the body of the pole through special saw machine. It fits tightly on the pole and is equipped with a security lock. It ensures the desirable aesthetic result. Protection IP54 through elastic gasket at the electrical compartment and protection against external mechanical impact IK10. Finally, it is accompanied with a security lock ZINCOMETAL of a triangular socket. It is user-friendly.

### Connection and safety of electrical circuit

Junction boxes



Range A-M1, A-M3

Junction boxes are made from polyamide resins, self-extinguishing and infrangible IP43 (A-M1) and IP54 (A-M3) and IK08 (A-M1, A-M3). It is suitable for poles of section  $\Phi 102$  (A-M1, A-M3).

Aluminium door cover



PG A1

An alternative choice of a door opening is the aluminium protective cover with a special lock and its own key for easy use. Protection IP55 through elastic gasket at the electrical compartment and protection against external mechanical impact IK08. It is suitable for poles of section  $\Phi 100$ - $\Phi 110$  (PG A1).

## Top's accessories

T Series



Die-cast aluminium top accessory  $\Phi 60$  for fitting in the luminaire for pole spigot  $\Phi 102$  (T 60/102).

## Decorative details of the base

## Decorative bases

A big variety of ZINLUX decorative bases are suggested in order to provide an elegant architectural result. They perfectly cover the base plate and protect the anchor bolts.

Cast-iron base "S<sub>1</sub>"

Decorative cast-iron base "Simple" type of S<sub>1</sub> height 70mm and diameter  $\Phi 340$ mm. Material's quality is EN-GJL-200 according to DIN 1561 with the minimum strength 200MPa .

Cast-iron base "S<sub>2</sub>"

Decorative cast-iron base "Simple" type of S<sub>2</sub> height 165mm and diameter  $\Phi 340$ mm (B-S2/1R/102). Material's quality is EN-GJL-200 according to DIN 1561 with the minimum strength 200MPa .

## Pole anchor bases

## Prefab anchor base

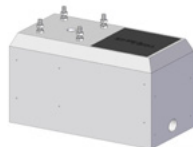

ZINCOMETAL prefab concrete base is an innovative product which aims to cover every project needs.

**Benefits:**

- Durability and Strength.
- Easy and flexible electrical works.
- It can be transported to the project.
- Installation and completion in real time to minimize cost and time.

PR-M/800/190/16 ZINCOMETAL prefab concrete base 800x600x550mm is equipped with 4 hot dip galvanized anchor bolts M16x500mm in arrangement 190x190mm, the manwhole, the tube in which the cable pass through and the necessary equipment/accessories.

**Anchor base**













Another alternative suggestion for installation in real time is the pole anchor base, which is delivered hot dip galvanized.

BAG M16/50/Z/190 Pole anchor base with 4 anchor bolts M16 of 500mm length each one, in arrangement 190x190mm.

## Table of ZINLUX RUSTIC ST-R

## With base plate

											
							Junction box	Anchor base		Prefab base	
Code	mm	mm	mm	mm	mm	mm	Code	Code	mm	mm	Code
RUSTIC ST-R303T	3000	Φ102	3	Φ310x10	300x70	350	A-M3 A-M1	<b>BAG M16/50/Z/190</b>	M16x500	190x190	PR-M/800/190/16
RUSTIC ST-R304T	4000										

## 1.6.3. ZINLUX RUSTIC ST-CR

**With base plate**

Pole drawing model

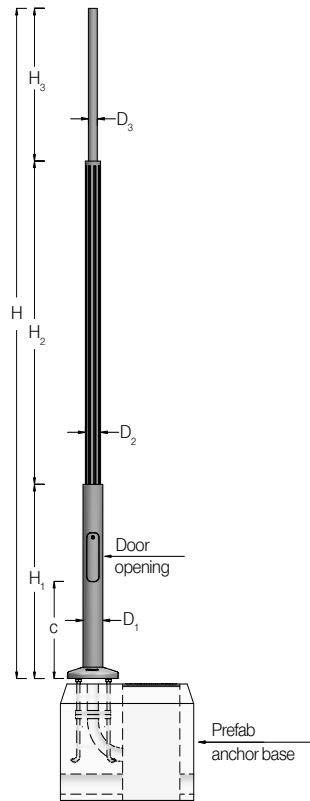

- Introduction** Decorative steel stepped lighting pole ZINLUX RUSTIC ST-CR with stripped surface of circular cross-section, with circular base plate in combination with a decorative cast-iron base.
- Material** Steel tube from hot rolled steel grade S235JR according to EN10025 manufactured to EN 10219.
- Surface protection** Hot-dip galvanized according to International Standard EN ISO 1461 and electrostatic powder coating surface finish (Duplex System).
- Technical features** The lighting poles are consisted from two (2) tubes with different diameters with smooth surface and (1) tube of stripped surface, which are penetrated at 0.10m inside the tube with the bigger diameter. They are welded in the joint parts in automatic welding machines. A "SINGLE" or "DOUBLE" bracket from our RUSTIC Collection is adjusted to the upper piece of the pole through cast-iron rings. For a better static analysis there is a base plate of circular cross-section which is totally covered by a decorative cast-iron base. Door opening is made from the body of the pole through special saw machine (IP54 and IK10). It fits tightly and it's equipped with security lock. Manufacturing according to EN-40.
- Certificates** CE Certificate of Notified European Body (EN-40, European Commission).

## Cross-section

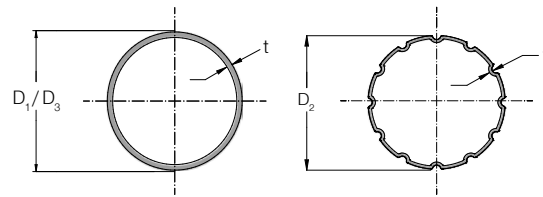

Stepped circular cross-section with stripped surface ( $D_1$ : 1<sup>st</sup> part cross-section,  $D_2$ : 2<sup>nd</sup> part cross-section,  $D_3$ : 3<sup>rd</sup> part cross-section,  $t$ : thickness).

## Door opening

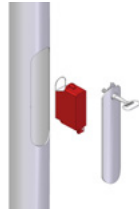

Door opening is made from the body of the pole through special saw machine. It fits tightly on the pole and is equipped with a security lock. It ensures the desirable aesthetic result. Protection IP54 through elastic gasket at the electrical compartment and protection against external mechanical impact IK10. Finally, it is accompanied with a security lock ZINCOMETAL of a triangular socket. It is user-friendly.

**Connection and safety of electrical circuit**

## Junction boxes

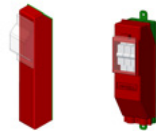

## Range A-M3A, A-M4

Junction boxes are made from polyamide resins, self-extinguishing and infrangible IP43 (A-M4) and IP54 (A-M3A) and IK08 (A-M3A). It is suitable for poles of section  $\geq \Phi 120$  (A-M3A, A-M4).

## Aluminium door cover



## PG A2

An alternative choice of a door opening is the aluminium protective cover with a special lock and its own key for easy use. Protection IP55 through elastic gasket at the electrical compartment and protection against external mechanical impact IK08. It is suitable for poles of section  $\Phi 120$ - $\Phi 166$  (PG A2).

**Top's accessories**

TD-IR Series

**Decorative tops**

Cast-iron top accessory for lighting poles of section  $\Phi 60$  (TD-IR-60C) and  $\Phi 76$  (TD-IR-76C).

TD-IR/SF Series



Cast-iron top accessory in "sphere" form  $\Phi 60$  for lighting poles of section  $\Phi 60$  (TD-IR-60SF/60) and  $\Phi 76$  (TD-IR-60SF/76).

**Decorative details of the base****Decorative bases**

A big variety of ZINLUX decorative bases are suggested in order to provide an elegant architectural result. They perfectly cover the base plate and protect the anchor bolts.

Cast-iron base "S<sub>1</sub>"

Decorative cast-iron base "Simple" type of S<sub>1</sub> height 70mm and diameter  $\Phi 340$ mm. Material's quality is EN-GJL-200 according to DIN 1561 with the minimum strength 200MPa .

Cast-iron base "S<sub>3</sub>"

Decorative cast-iron base "Simple" type of S<sub>3</sub> height 190mm and diameter  $\Phi 420$ mm. Material's quality is EN-GJL-200 according to DIN 1561 with the minimum strength 200MPa .

## Prefab anchor base

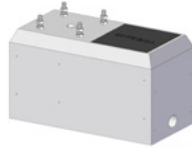
**Pole anchor bases**

ZINCOMETAL prefab concrete base is an innovative product which aims to cover every project needs.

**Benefits:**

- Durability and Strength.
- Easy and flexible electrical works.
- It can be transported to the project.
- Installation and completion in real time to minimize cost and time.

PR-M/800/190/16 ZINCOMETAL prefab concrete base 800x600x550mm is equipped with 4 hot dip galvanized anchor bolts M16x500mm in arrangement 190x190mm, the manwhole, the tube in which the cable pass through and the necessary equipment/accessories.

PR-M/1000/235/20 ZINCOMETAL prefab concrete base 1000x500x700mm is equipped with 4 hot dip galvanized anchor bolts M20x600mm in arrangement 235x235mm, the manwhole, the tube in which the cable pass through and the necessary equipment/accessories. If it is necessary, it can be used as a primary base in order to construct a bigger one.

## Anchor base













Another alternative suggestion for installation in real time is the pole anchor base, which is delivered hot dip galvanized.

BAG M16/50/Z/190 Pole anchor base with 4 anchor bolts M16 of 500mm length each one, in arrangement 190x190mm.

BAG M20/60/Z/235 Pole anchor base with 4 anchor bolts M20 of 600mm length each one, in arrangement 235x235mm.

## Table of ZINLUX RUSTIC ST-CR

## With base plate

												
								Junction box	Anchor base			Prefab base
Code	mm	mm	mm	mm	mm	mm	mm	Code	Code	mm	mm	Code
RUSTIC ST-CR 300/133/60T	3000	1000/1000/1000	Φ133/Φ102/ Φ60	3	Φ310x10	300x80	600	A-M3A A-M4	BAG M16/50/Z/190	M16x500	190x190	PR-M/800/190/16
RUSTIC ST-CR 350/133/60T	3500	1000/1500/1000										
RUSTIC ST-CR 400/133/60T	4000	1200/1600/1200										
RUSTIC ST-CR 500/133/60T	5000	1500/2000/1500										
RUSTIC ST-CR 600/159/60T	6000	1500/3000/1500	Φ159/Φ102/ Φ60	3	Φ400x12	300x85	800	A-M3A A-M4	BAG M20/60/Z/235	M20x600	235x235	PR-M/1000/235/20
RUSTIC ST-CR 600/159/76T		1500/3000/1500	Φ159/Φ102/ Φ76		Φ400x15							
RUSTIC ST-CR 700/159/76T		2000/3000/2000	Φ159/Φ102/ Φ76		Φ400x15							



[www.zincometal.gr](http://www.zincometal.gr)

**Δ.** 10ο χλμ. Κιλκίς-Πολυκάστρου  
61100 Κιλκίς, τ.θ. 21  
**AD.** 10th km. Kilkis - Polikastro  
P.C. 61100 Kilkis, Greece

**T.** +30 23410 75651-3  
+30 23410 71581  
**F.** +30 23410 71734

**E.** info@zincometal.gr  
**WEB.** www.zincometal.gr

The logo for ZIN lux lighting, featuring a stylized light fixture icon and the text "zin lux lighting" below it.

zin  
lux  
lighting

The logo for hellenic griglia, featuring a stylized grid icon and the text "hellenic griglia" below it.

hellenic griglia